

寸法図

NKW01008

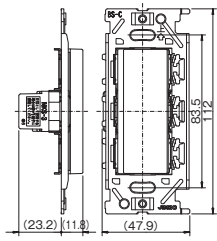

NKW01009

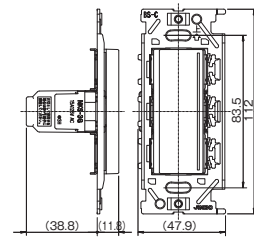

NKW01012

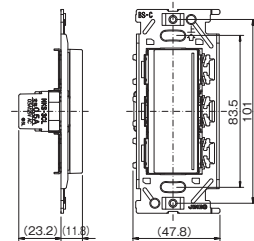

NKW01013

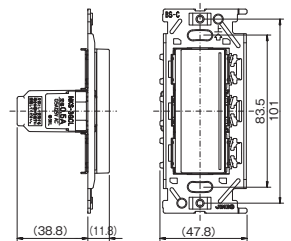

KAG-1500

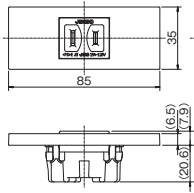

KAG-1509

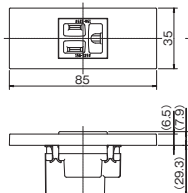

KAG-1503  
KAG-1506

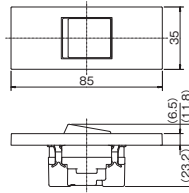

KAG-1512  
KAG-1518

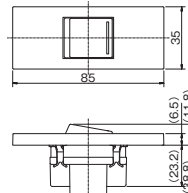

KAG-1515

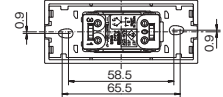
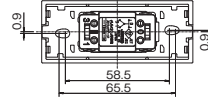
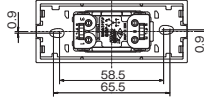
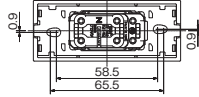
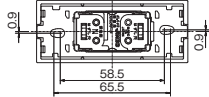
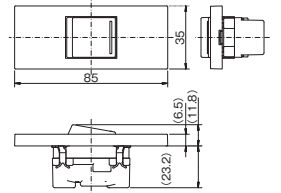

KAG-2500

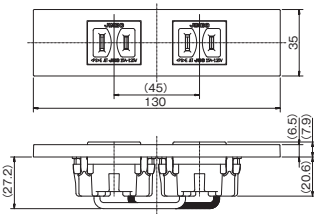

KAG-2509

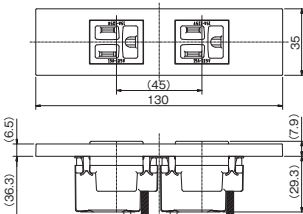

KAG-2512

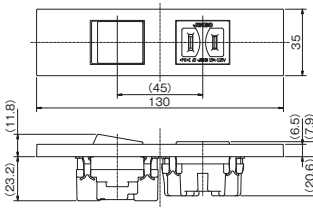

KAG-2536

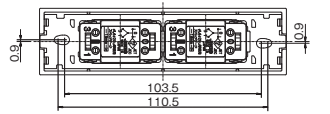
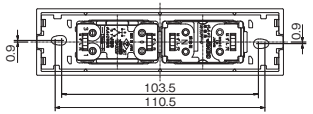
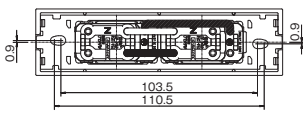
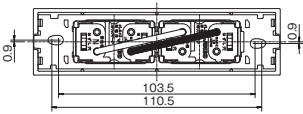
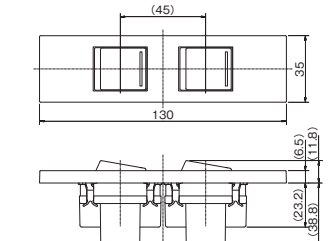

NKW-RLE5S3  
NKW-RTE2S3

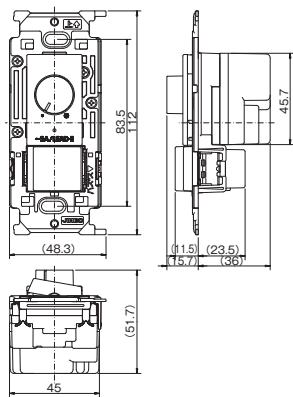

NKW-RLE5S3G  
NKW-RTE2S3G

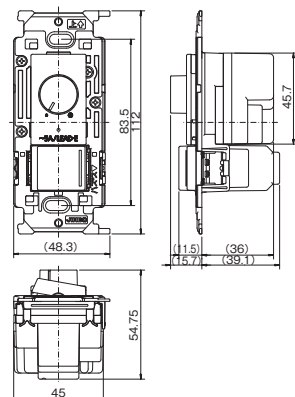

NKW-RPWM1S3

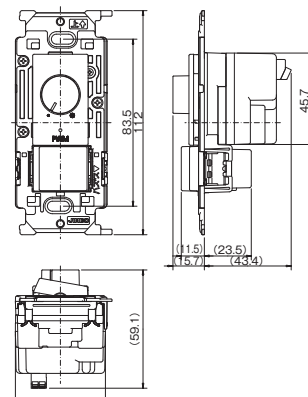

NKW-RPWM1S3G

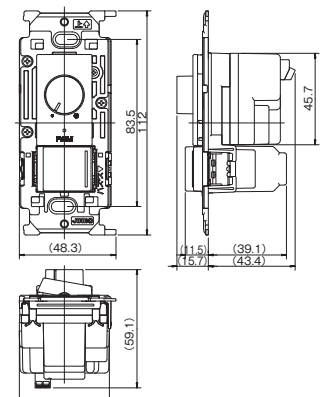

受注品 納期区分 受注後20日~30日で出荷します。 受注後30日~45日で出荷します。 特別注文にて生産を承ります。

カセットタイプ 製品に関する注意事項です。 特筆すべき注意・警告を示しています。

詳細につきましては、最寄りの当社営業所にご確認ください。